







LEMMIKKI PÖYTÄ

TYP	KOKO	NRO	KPL
	6 x 70	A	2
	6 x 50	B	4
	6 x 50	C	8
	M 6	D	6
	M 6	E	6
			1

NIMIKE	KPL
KANSI	1
JALKA	2+2
VÄLITUKI	2
APUPALA	2



HUOMIOI JALKOJEN APUREIKIEN KÄTISYYS

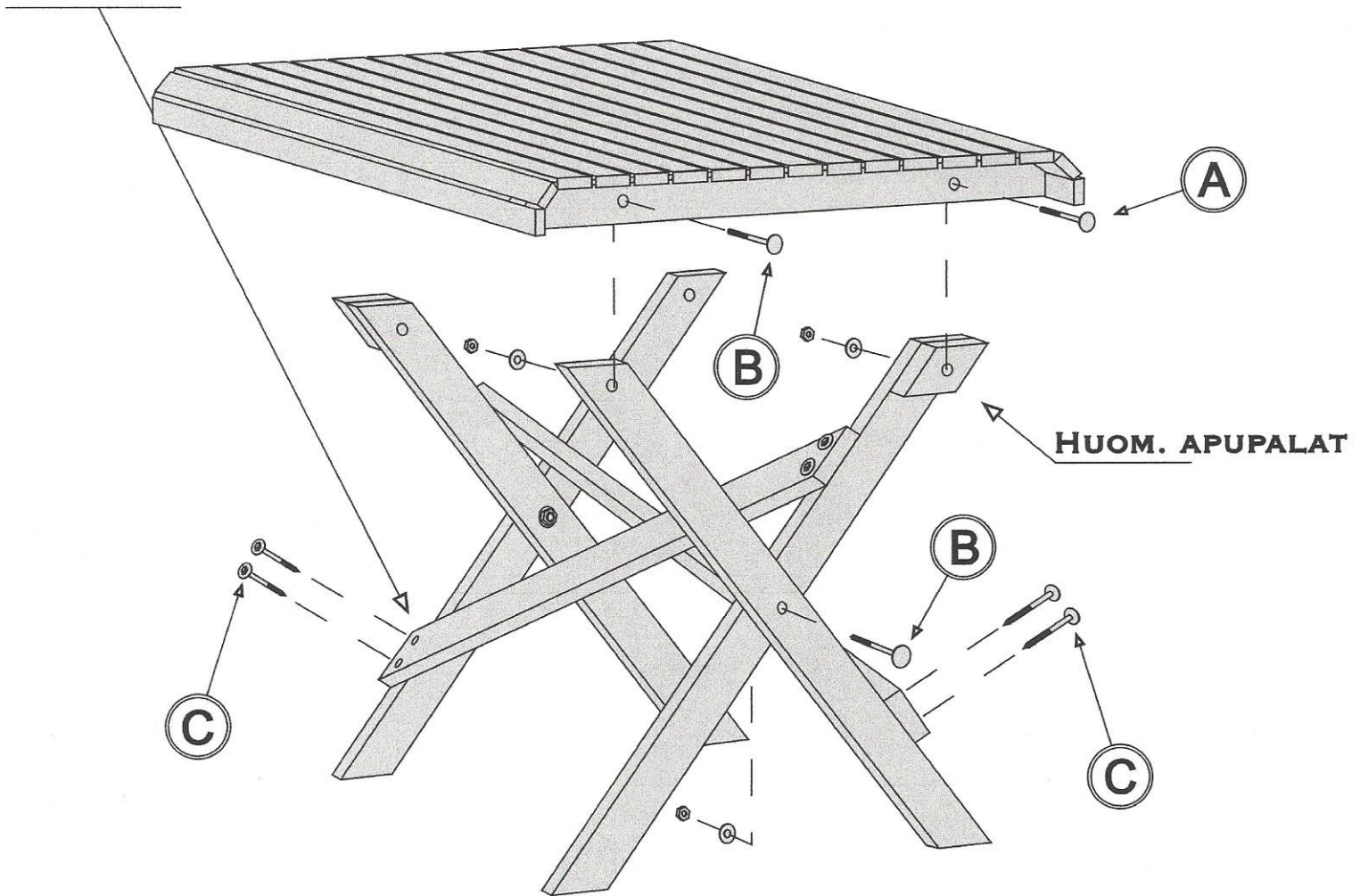

**RUUVIEN KIRISTYS 2 VIIKON KÄYTÖN JÄLKEEN.
PUOSIEN KÄSITTELY TARPEEN VAATIESSA PAIN-
KYLLÄSTETYLLÄ PUULLLE TARKOITETULLA PUUÖLJYLLÄ.**